

WESTCOAT POST FLASHING & REGLET DETAIL

NOT TO SCALE

NOTES:

- APPLY WP-51 ON ALL FLASHING SEAMS AND OVERLAPS. STANDARD OVERLAP IS BOTTOM TO TOP WITH A 4" OVERLAP.
- 2500 PSI MINIMUM FOR CONCRETE SUBSTRATES
- $\frac{5}{8}$ " EXTERIOR GRADE MINIMUM FOR PLYWOOD SUBSTRATE
- $\frac{1}{4}$ " MINIMUM SLOPE REQUIRED ON ALL DECKS
- REFER TO LOCAL BUILDING CODES & STANDARDS

**SITE BUILT
REGLET**

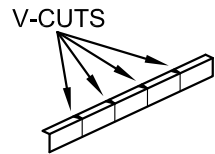

FOLD ALONG VERTICAL
LINES (2 SIDES WILL
OVERLAP)

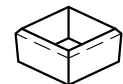
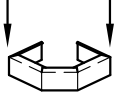

FINISHED
FORM

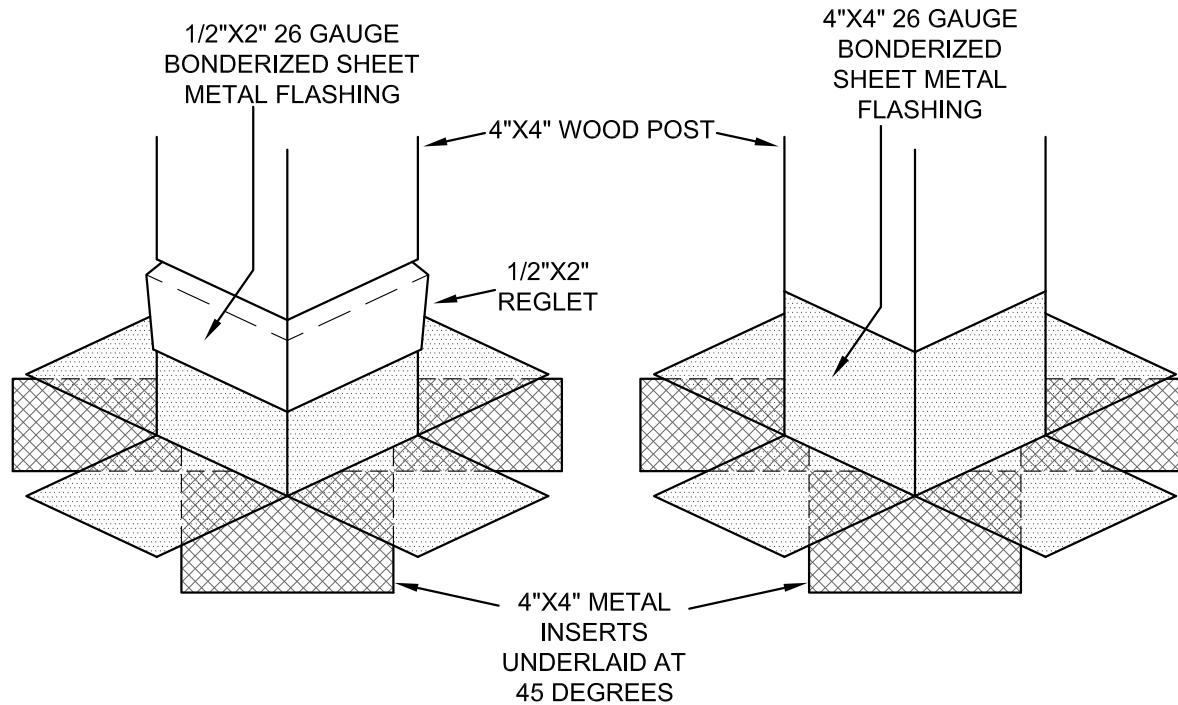

**SITE BUILT
FLASHING**

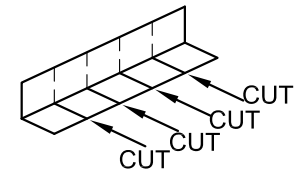

FOLD AT EA. VERTICAL
LINE (2 SIDES WILL
OVERLAP)

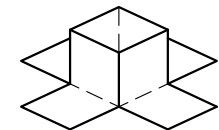
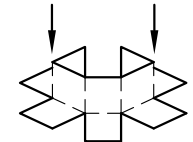

FINISHED
FORM

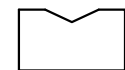

INSERT

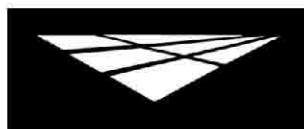

westcoat

800-250-4519
770 GATEWAY CENTER DRIVE

www.westcoat.com
SAN DIEGO, CA. 92102